

Q 6 1.4T



25

8 1.4T

- : ZL201220332872.4
 - : ZL201220041902.6
 - : ZL201210028744.5
 - : ZL20162025241.6
 - : ZL201310335484.0
- | | | |
|-----|--------|---------------|
| | [2012] | 156 |
| | [2012] | 333 |
| JK | [2012] | 1050 |
| PCT | | CN2011/082524 |

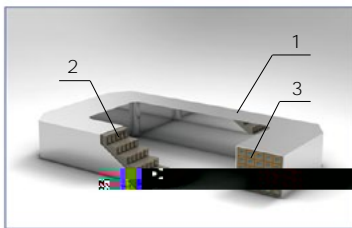

1 2 3

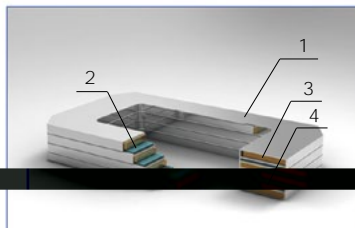

1 2 3 4

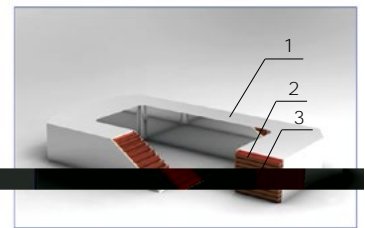

1 2 3

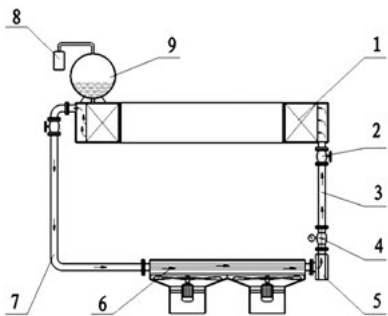

1.
2.
3.
4.
5.
6.
7.
8.
9.

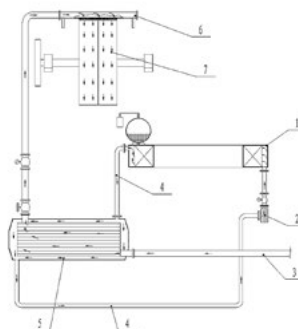

1-
2-
3-
4-
5-
6-
7-

	LHGC- 1000F	LHGC- 1250F	LHGC- 1500F	LHGC- 1750F	LHGC- 2000F	LHGC- 2250F	LHGC- 2500F	LHGC- 2750F	LHGC- 3000F	LHGC- 3500F	LHGC- 4000F	LHGC- 5000F
(T)	1. 1/ 1. 4(0. 6)											
	2. 0/ 2. 4(1. 1)											
kW	17/ 28(10)	19/ 40(12)	32/ 38(15. 5)	37/ 55(23)	49/ 65(29)	51/ 70(32)	65/ 76(41)	69/ 92(42)	72/ 106(50)	93/ 139(52)	102/ 128(58)	120/ 138(75)
t/h	2 3. 5	5 9	10 15	15 25	25 40	33 60	40 75	50 100	75 125	125 200	175 275	300 400
m ³ /h	12. 5 20	20 50	50 100	75 150	100 200	160 300	200 400	200 500	350 650	550 1000	750 1400	1400 2000
A	41/ 85(70)	85/ 125(85)	110/ 130(110)	130/ 150(125)	140/ 180(130)	146/ 195(120)	165/ 206(120)	225/ 200(100)	185/ 270(150)	205/ 330(180)	256/ 345(205)	320/ 365(200)
%	10 35											
mm	- 1. 2											
r/min	2 4											
mm	1000	1250	1500	1750	2000	2250	2500	2750	3000	3500	4000	5000
kW	1. 1	1. 5	3	4	5. 5	7. 5	11 7. 5	15	18. 5 15	30	37	55
DCV	0 514()											
Mpa	0. 2 0. 4											
m ³ /h	8 12	12	0. 4					5T(

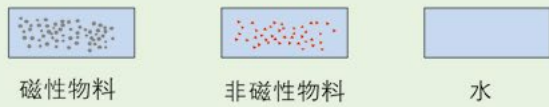
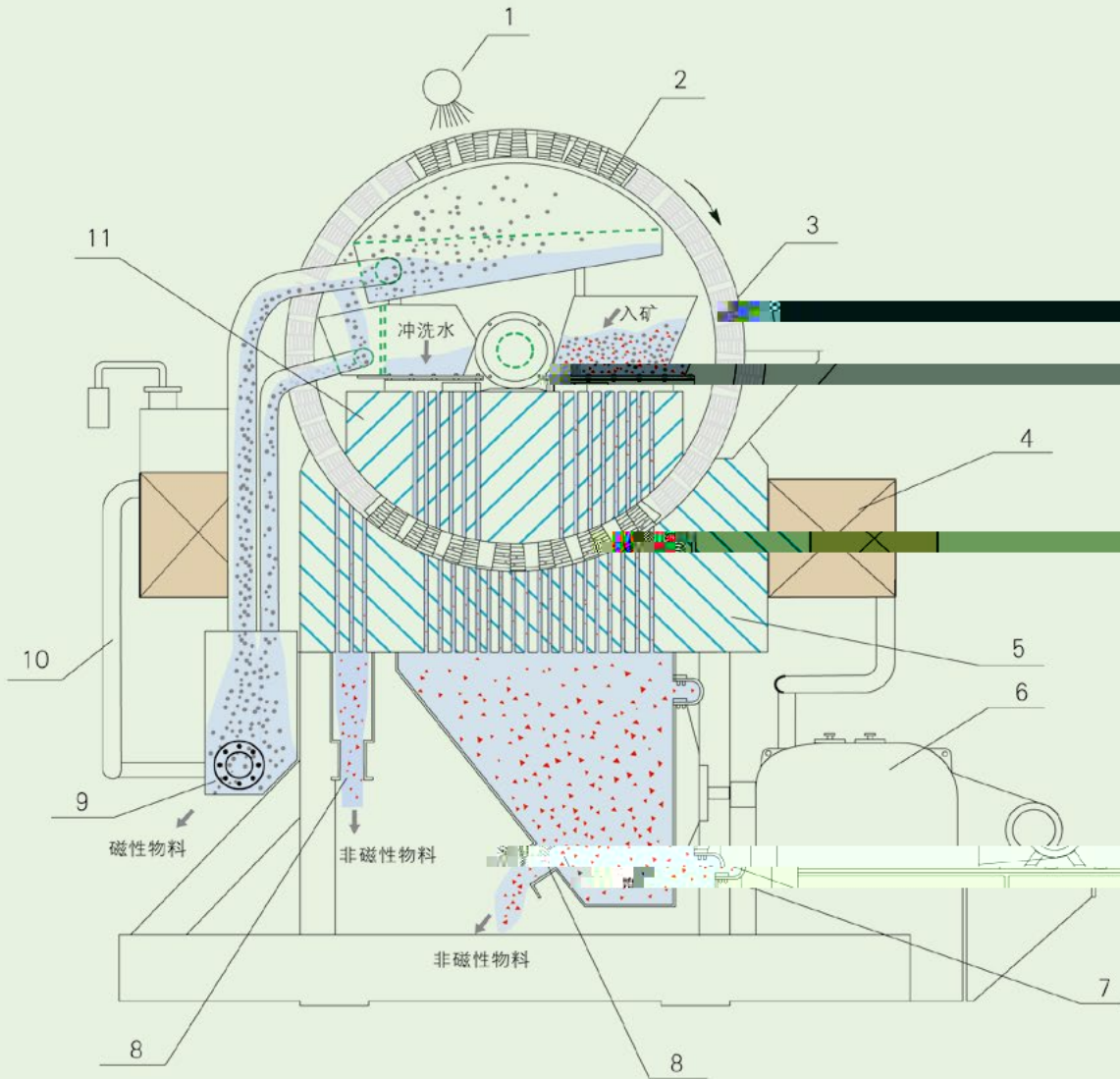

1. 卸矿水 2. 磁介质 3. 转环 4. 励磁线圈 5. 下磁极 6. 脉动装置
 7. 橡胶鼓膜 8. 非磁性物料出口 9. 磁性物料出口 10. 油冷系统 11. 上磁极

磁场对物料吸力的计算： $F_m = K \cdot X_s \cdot B \cdot \Delta H \cdot V$

(F_m —磁场对物料的吸力 K —吸力常数 X_s —比磁化系数 B —分选磁场强度 ΔH —分选磁场梯度 V —物料粒度)